

Features

- High luminous Flux LEDs
- 4.8mm Straw Standard Directivity
- Superior Weather-resistance
- UV Resistant Epoxy
- Water Clear Type

Applications

- Backlighting (illuminated advertising etc.)
- Substitution of Micro Incandescent Lamps
- Reading Lamps / Emergency Lighting
- Marker lights (e.g. steps, exit ways, etc.)
- Other Lighting

Outline Dimension

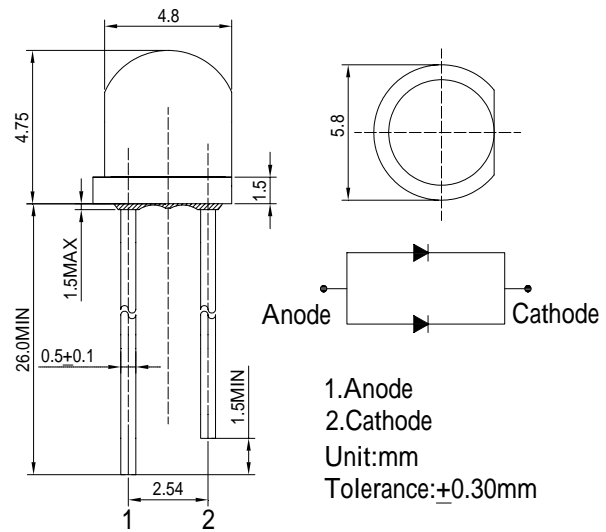

Absolute Maximum Rating

(Ta=25 °C)

Item	Symbol	Value	Unit
DC Forward Current	I_F	60	mA
Pulse Forward Current*	I_{FP}	120	mA
Reverse Voltage	V_R	5	V
Power Dissipation	P_D	216	mW
Operating Temperature	T_{opr}	-30 ~ +85	
Storage Temperature	T_{stg}	-40 ~ +100	
Lead Soldering Temperature	T_{sol}	260 /5sec	-

*Pulse width Max 10ms , Duty ratio max 1/10

Directivity

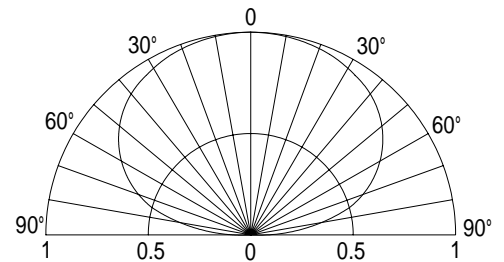

Electrical -Optical Characteristics

(Ta=25 °C)

Item	Symbol	Condition	Min.	Typ.	Max.	Unit
DC Forward Voltage	V_F	$I_F=50mA$	2.9	3.1	3.6	V
DC Reverse Current	I_R	$V_R=5V$	-	-	10	μA
Luminous Flux	ν	$I_F=50mA$	-	20	-	lm
Color Temperature	CCT	$I_F=50mA$	-	6500	-	K
Chromaticity Coordinates*	x	$I_F=50mA$	-	0.31	-	
	y	$I_F=50mA$	-	0.33	-	
50% Power Angle	$2\theta_{1/2}$	$I_F=50mA$	-	150	-	deg

*1 Tolerance of chromaticity coordinates is ±10%

*2 Tolerance of luminous intensity is ±15%